

Recombinant Monoclonal Antibodies

Antibodies developed from a **NON-ANIMAL SOURCE** using *in vitro* antibody phage display technology

Features:

- Developed from a human antibody phage display library.
- Consists of scFv (single chain fragment variable) composed of VH (variable domain of the human immunoglobulin heavy chain) and VL (variable domain of the human immunoglobulin light chain) fused to a Fc region.
- Produced in mammalian cells (CHO or HEK 293).
- Similar properties compared to monoclonal antibodies developed in mice / rat (e.g. affinity in the low nanomolar range).
- Standard secondary antibodies can be used.
- Ideal for conserved antigens (which are poorly immunogenic in animals).
- Detect conformational epitopes (e.g. GTP-bound proteins).
- Detect protein modifications (e.g. phosphorylations, ubiquitinations).
- Possibility to exchange the Fc region with Fc from other species.

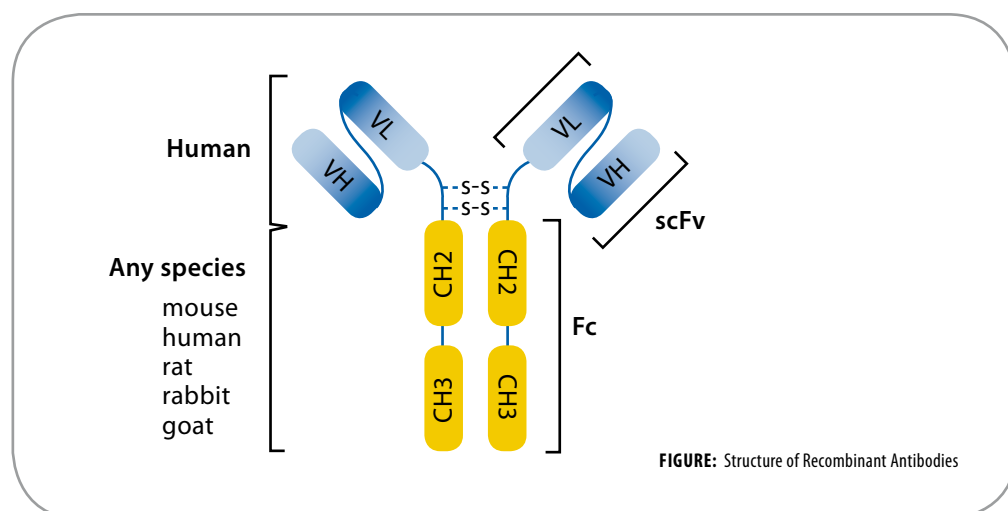

FIGURE: Structure of Recombinant Antibodies

New Recombinant Antibodies

anti-APRIL (mouse), mAb (rec.) (blocking) (Apyr-1-1)

AG-27B-0001-C100 100 µg
 AG-27B-0001PF-C100 (Preservative Free) 100 µg

Clone: Apyr-1-1
Isotype: Mouse IgG2bλ
Immunogen: Mouse APRIL (aa 98-232)
Specificity: Recognizes mouse APRIL
Application: ELISA, IP, FUNC (Inhibits binding of mouse APRIL to mouse BCMA and TACI)

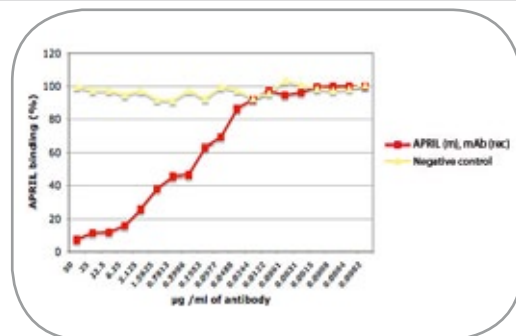

FIGURE: Binding of mouse APRIL to mouse BCMA is inhibited by anti-APRIL (mouse), mAb (rec.) (blocking) (Apyr-1-1) (Prod. No. AG-27B-0001).

anti-EGFP, mAb (rec.) (G3)

AG-27B-0007-C100 100 µg

Clone: G3
Isotype: Human IgG2bλ
Immunogen: Enhanced green fluorescent proteins (EGFP)
Specificity: Recognizes EGFP, enhanced cyan fluorescent protein (ECFP) and enhanced yellow fluorescent protein (EYFP)
Application: ELISA, ICC, IP, WB

LIT: S. Moutel, et al.; Biotech. J. 4, 38 (2009)

anti-Giantin, mAb (rec.) (TA10)

AG-27B-0003-C100 100 µg
 AG-27B-0003TD-C100 (ATTO 488) 100 µg

Clone: TA10
Isotype: Human IgG2bλ
Immunogen: Human recombinant giantin
Specificity: Recognizes human and mouse giantin
Application: ICC

LIT: C. Nizak, et al.; Traffic 7, 739 (2003) • O. Vielemeyer, et al; BMC Biotechnol. 10, 59 (2010)

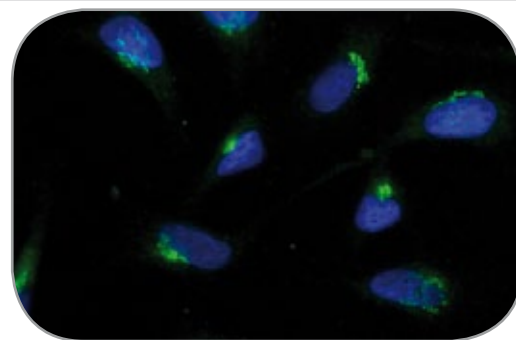

FIGURE: Human giantin is detected by immunocytochemistry using anti-giantin, mAb (rec.) (TA10) (ATTO 488) (Prod. No. AG-27B-0003TD). Picture courtesy of Dr. Sandrine Moutel & Dr. Franck Perez Lab, Curie Institute, Paris.

anti-HMGB1, mAb (rec.) (Giby-1-4)

AG-27B-0002-C100 100 µg

Clone: Giby-1-4
Isotype: Human IgG2bλ
Immunogen: Human recombinant HMGB1
Specificity: Recognizes human, mouse and rat HMGB1
Application: ELISA, WB

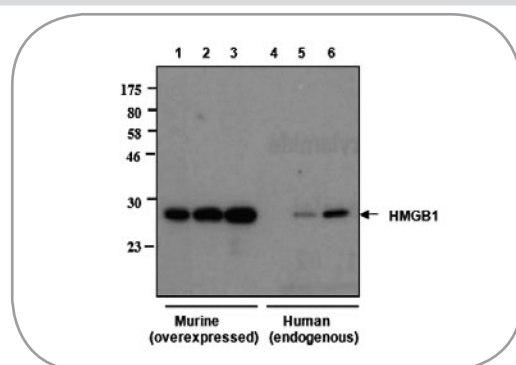

FIGURE: Western blot analysis of human and rat HMGB1 using anti-HMGB1, mAb (rec.) (Giby-1-4) (Prod. No. AG-27B-0002). Different amounts of cell extracts from HEK293T cells (3µg, 5µg and 30µg) either transfected with a plasmid coding for rat HMGB1 (lanes 1, 2, 3) or non-transfected (lanes 4, 5, 6), were separated by SDS-PAGE under reducing conditions, transferred to nitrocellulose and incubated with anti-HMGB1, mAb (rec.) (Giby-1-4) (1µg/ml). Proteins were visualized by a chemiluminescence detection system.

anti-Myosin IIA (non-muscle) (heavy chain), mAb (rec.) (SF9)

AG-27B-0010-C100	100 µg
Clone:	SF9
Isotype:	Human IgG2bλ
Immunogen:	Full length myosin IIA from rat liver
Specificity:	Recognizes human, mouse, rat and drosophila myosin IIA (heavy chain)
Application:	ELISA, ICC, WB, EM

LIT: C. Nizak, et al.; Traffic 7, 739 (2003)

FIGURE: Human myosin IIA (non-muscle) (heavy chain) is detected by immunocytochemistry using anti-myosin IIA (non-muscle) (heavy chain), mAb (rec.) (SF9) (Prod. No. AG-27B-0010). Picture courtesy of Dr. Sandrine Moutel & Dr. Franck Perez Lab, Curie Institute, Paris.

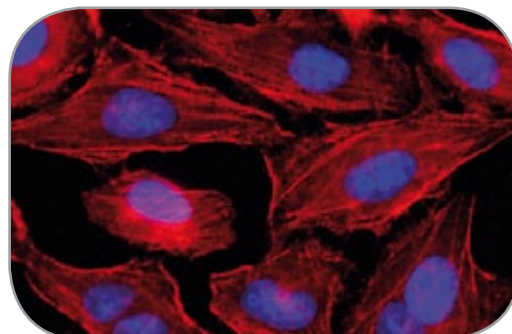
**anti-Rab1-GTP, mAb (rec.) (ROF7)**

AG-27B-0006-C100	100 µg
Clone:	ROF7
Isotype:	Human IgG2bλ
Immunogen:	Full length canine Rab1
Specificity:	Recognizes human, mouse, rat and canine Rab1a-GTP and Rab1b-GTP
Application:	ICC, IP

LIT: O. Vielemeyer, et al; BMC Biotechnol. 10, 59 (2010)

FIGURE: Rab1-GTP is detected by immunocytochemistry using anti-Rab1-GTP, mAb (ROF7) (Prod. No. AG-27B-0006). Picture courtesy of Dr. Sandrine Moutel & Dr. Franck Perez Lab, Curie Institute, Paris.

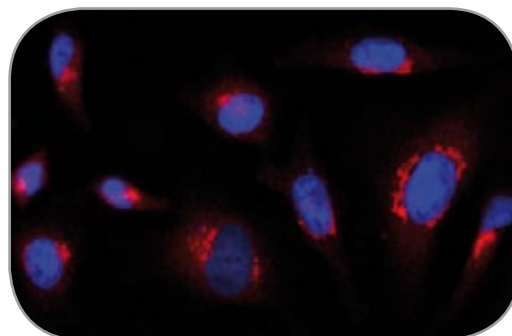
**anti-Rab6-GTP, mAb (rec.) (AA2)**

AG-27B-0004-C100	100 µg
AG-27B-0004TD-C100	(ATTO 488) 100 µg
Clone:	AA2
Isotype:	Human IgG2bλ
Immunogen:	Recombinant Rab6AQ72L, a GTP-locked mutant of Rab6A in which Gln72 is replaced by Leu
Specificity:	Recognizes human, mouse and drosophila GTP-bound Rab6a and Rab6b and mutant Rab6Q72L Does not detect Rab6-GDP
Application:	ICC, WB (only AG-27B-0004)

LIT: C. Nizak, et al.; Science 300, 984 (2003) • E. Del Nery, et al.; Traffic 7, 394 (2006)
• O. Vielemeyer, et al; BMC Biotechnol. 10, 59 (2010)

FIGURE: Rab6-GTP is detected by immunocytochemistry using anti-Rab6-GTP, mAb (AA2) (Prod. No. AG-27B-0004). Picture courtesy of Dr. Sandrine Moutel & Dr. Franck Perez Lab, Curie Institute, Paris.

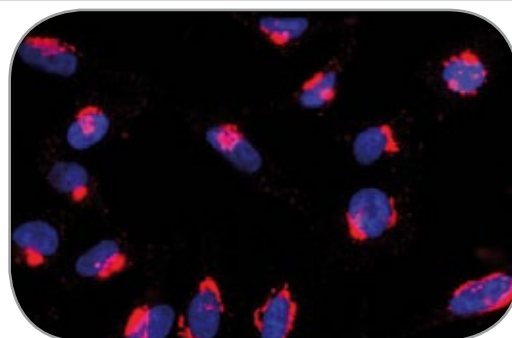

anti- α -Tubulin, mAb (rec.) (F2C)

AG-27B-0005-C100 100 μ g
 AG-27B-0005TD-C100 (ATTO 488) 100 μ g

Clone: F2C
Isotype: Human IgG2b λ
Immunogen: Bovine brain tubulin
Specificity: Recognizes human, mouse and bovine α -tubulin
Application: ICC, WB (only AG-27B-0005)

LIT: C. Nizak, et al.; Traffic 7, 739 (2003) • O. Vielemeyer, et al; BMC Biotechnol. 10, 59 (2010)

FIGURE: Human α -tubulin is detected by immunocytochemistry using anti- α -tubulin, mAb (rec.) (F2C) (Prod. No. AG-27B-0005). Picture courtesy of Dr. Sandrine Moutel & Dr. Franck Perez Lab, Curie Institute, Paris.

FIGURE: Human α -tubulin is detected by immunocytochemistry using anti- α -tubulin, mAb (rec.) (F2C) (ATTO 488) (Prod. No. AG-27B-0005TD). Picture courtesy of Dr. Sandrine Moutel & Dr. Franck Perez Lab, Curie Institute, Paris.

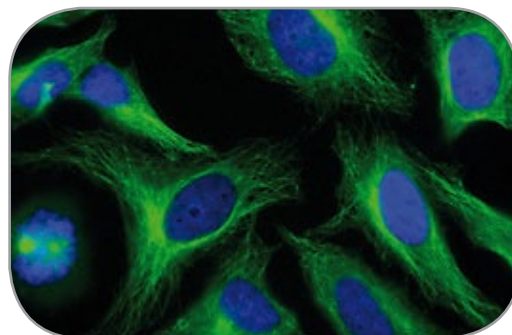
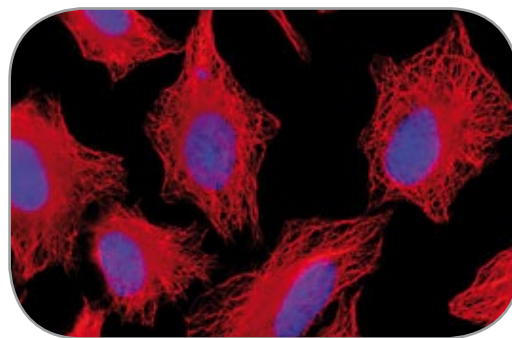
**anti- β -Tubulin, mAb (rec.) (S11B)**

AG-27B-0008-C100 100 μ g

Clone: S11B
Isotype: Human IgG2b λ
Immunogen: Full length tubulin from pig brain
Specificity: Recognizes human, mouse, rat, pig, drosophila and monkey β -tubulin
Application: ELISA, ICC, WB

LIT: C. Nizak, et al.; Traffic 7, 739 (2003)

FIGURE: Human β -tubulin is detected by immunocytochemistry using anti- β -tubulin, mAb (rec.) (S11B) (Prod. No. AG-27B-0008). Picture courtesy of Dr. Sandrine Moutel & Dr. Franck Perez Lab, Curie Institute, Paris.

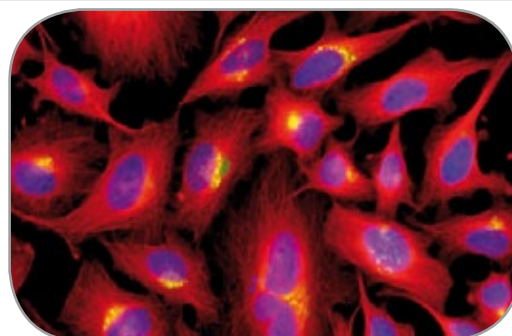
**anti-Tubulin-GTP, mAb (rec.) (MB11)**

AG-27B-0009-C100 100 μ g

Clone: MB11
Isotype: Human IgG2b λ
Immunogen: Full length GTP- λ -S loaded tubulin from pig brain
Specificity: Recognizes human, mouse and drosophila tubulin-GTP
Application: ICC

LIT: A. Dimitrov, et al.; Science 322, 1353 (2008)

Vinci-Biochem[®]